



GUANGDONG UNIHOPPER PRECISION TECHNOLOGY
CORPERATION LIMITED

Operating center: Rm2404 Building B, Fengxing Plaza, No.242,
Tianhe Rd, Tianhe District, Guangzhou City

Headquarter: Unihopper industrial park, No.9 Chuangye
road, High-tech Industrial Development Zone ,Zhaoqing City,
Guangdong Province, China

TEL: +86-758 3212918/3212919

FAX: +86-758 3212921

Email: pansheng@unihopper.biz

↙
www.unihopper.biz/en

2208-10K



Official wechat



Official website

On the premise of not influence the function and uality,Grasshopper reserves the right of changing the size,outlook without notice.
There will be a little color difference between the product in presswork and definite object.The correct size of the product subject to definite object.



WARDROBE

Designed by UNIHOPPER



WARDROBE



WARDROBE



Unihopper Intelligent industrial park



Unihopper R & D Building

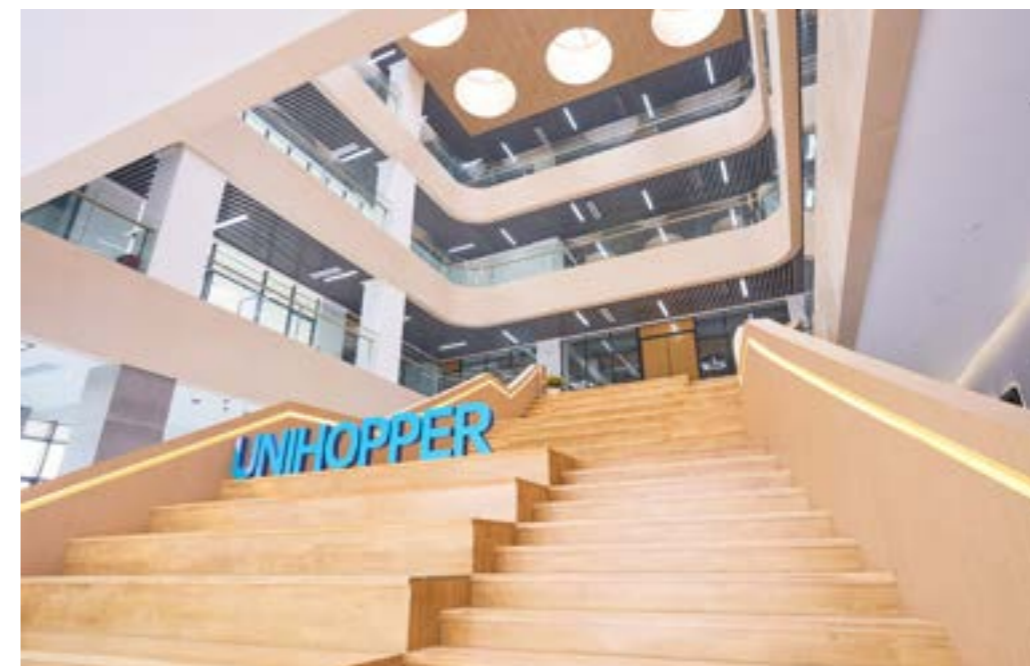

MILESTONES

2005 >

In order to reduce the cost of ODM, Unihopper decided to invest with the advanced technology from Europe and construct the production base in China.

2010 >

Unihopper successfully researched and developed the third generation interactive two-way soft closing drawer box and synchronize conceal slide.

2013 >

The union design group successfully researched and developed basket and wardrobe storage system (MOKA).

2015 >

Unihopper successfully researched and developed the fifth generation interactive two-way soft closing drawer box-Magic box, and successfully hosted the "Night of Unihopper" in Beijing wardrobe annual conference.

2016 >

Unihopper successfully hosted "Unihopper summit conference" in Guangzhou, and announced Unihopper would globalize the brand.

2017 >

Unihopper successfully hosted the second "Unihopper summit conference". Same time, Unihopper Business College was founded.

2019 >

Unihopper successfully hosted the third "Unihopper summit conference", and founded the new Unihopper production base and Unihopper brand-day. For better global development, Unihopper set up the "Belt and Road" concept. Same year, Unihopper researched and developed the Phantom kitchen storage system and Co-box.

2020 >

Unihopper become one of the home decoration drafting committee for Hinge, slide and basket. In the same year, Unihopper won the National High-tech Enterprise. Vanka, COKA have been introduced to the market.

2021 >

Unihopper new production base with 120,000 sqm put into use officially.

2022 >

Unihopper international R&D center and the flagship showroom in the new headquarters fully open to the public.

BRIEF INTRODUCTION

Unihopper, a high-end customized home brand and the provider for comprehensive solutions of hardware supporting, implements the "Belt and Road" global development strategy to develop the global market. Offering the Uni-products, Uni-design, and Uni-service to every corner of the world.

After years of development, Unihopper has sole agents in dozens of countries and regions around the world, such as Netherlands, Canada, Russia, Slovenia, Argentina, Korea, Iran, Spain, Portugal, Ireland, Saudi Arabia, Colombia, South Africa, India, Southeast Asia Regions and China HongKong, Macao and Taiwan regions and so on; and now, Unihopper has become a major suppliers for many well-known cabinet and home brands in the world.

In 2005, Unihopper set up a production base and established a large storage center in Nanhai city in China, and a new intelligent Uni-industrial park of more than 120,000 square meters will also be put into use in 2021. As one of the best name and provider for the high-end customized furniture hardware industry, Unihopper has always upheld the brand values of "European quality, Chinese price", and now, has become a leading brand popularizing in many home furnishing companies and consumers all over the world. In the future, Unihopper will increase more investment in space enlarging, strengthen multi-dimensional development including product application, intelligent scene introduction, online and offline channel integration, striving to become the best home storage master around consumers' life.



GS Quality Test
Certification



ISO 9001 Quality
Management Certification



Standards Maker of Kitchen
Hardware Industry

THE LAYOUT OF UNIHOPPER ALL OVER THE WORLD



COMPANY VISION

CORPORATE MISSION:

To meet people's yearning for a better life is the mission pursuit of Unihopper

VALUES:

Integrity, altruism, struggle, innovation, understanding, common progress







Make your home more tidy and orderly

Makes full use of the upper, middle and lower layers of wardrobe to design a storage box -- make your home more tidy and orderly.

INDEX

V

Venka P. 015-048

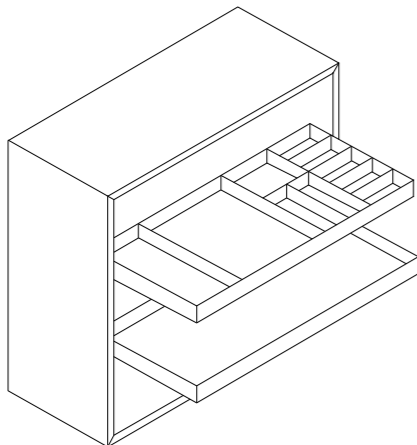

G

Glass Naka P. 085-102

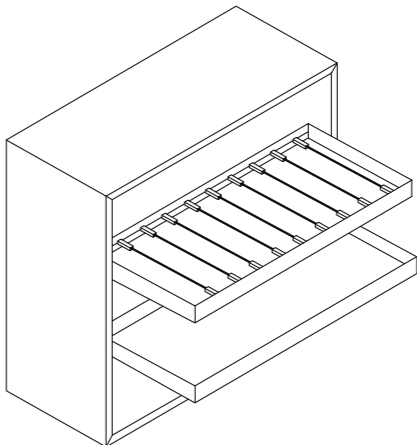

C

Coka P. 049-084

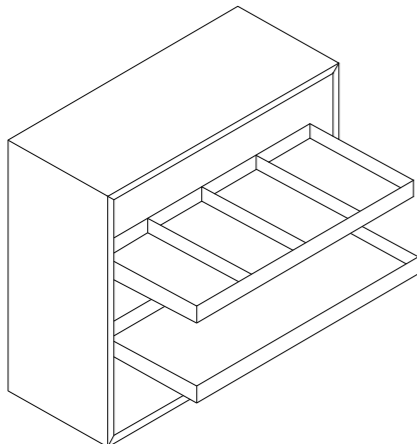

M

Moka P. 103-160

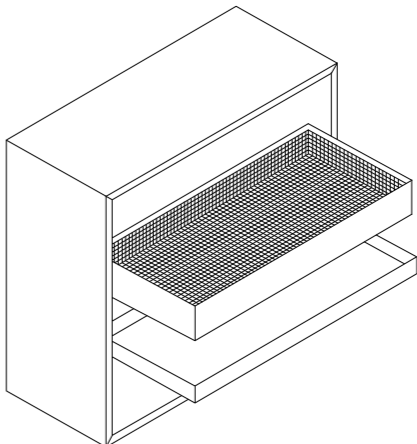

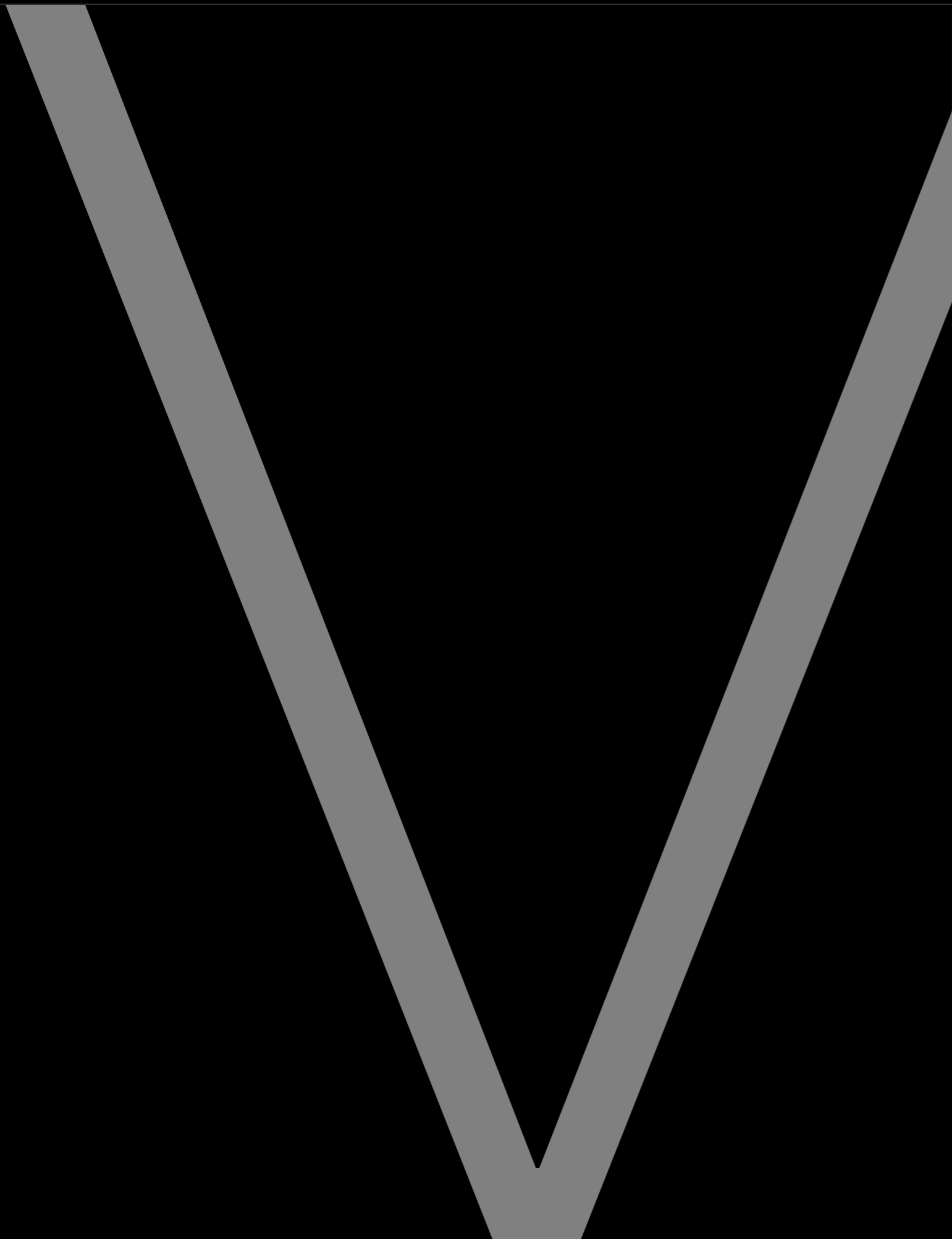

VENKA STORAGE SYSTEM



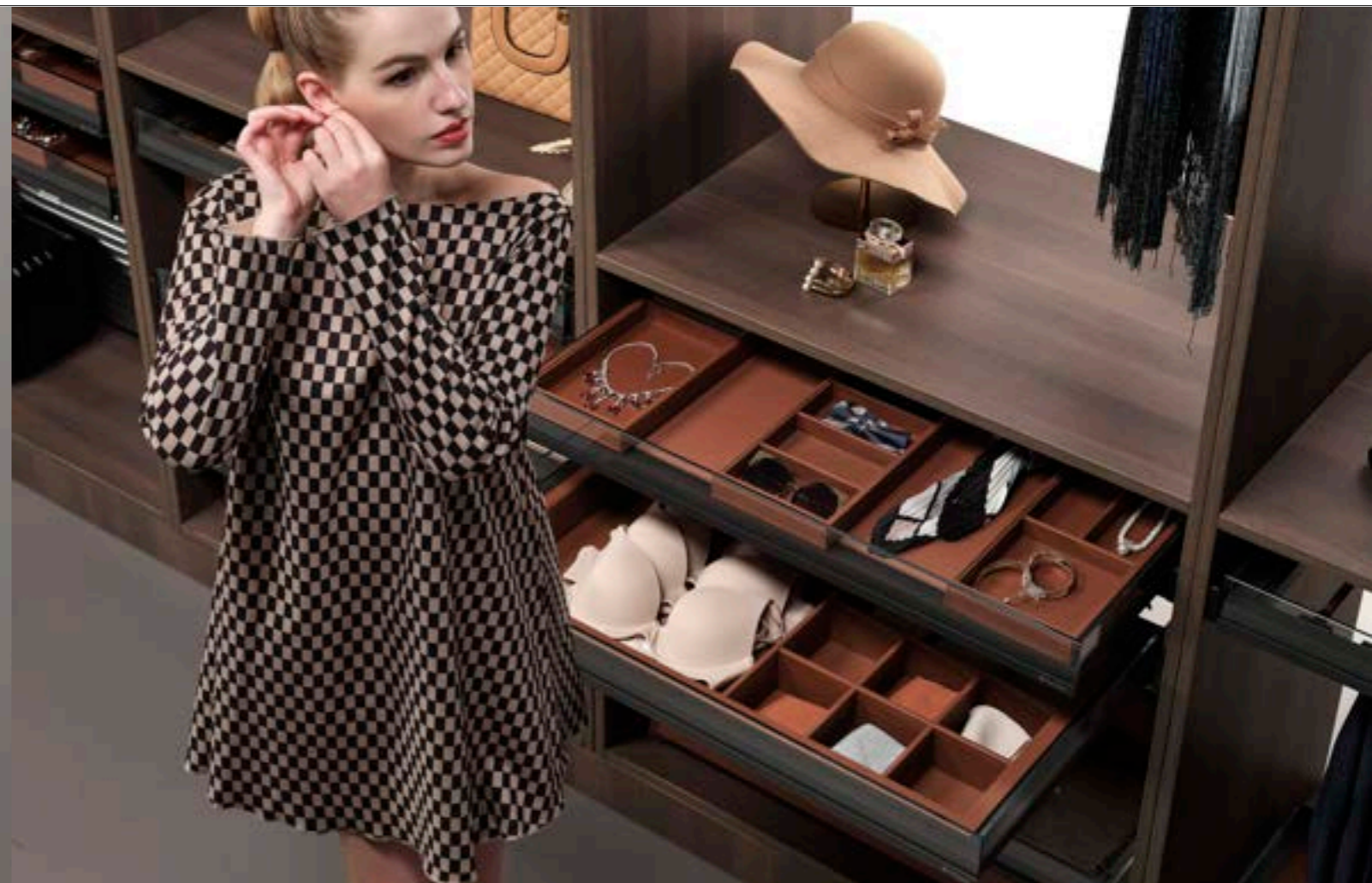

THE MULTIFUNCTIONAL STORAGE BOX PROVIDES YOU A
SIMPLE BUT LIGHT LUXURY HOME LIFE.



VENKA /
Leather multifunctional storage box

WITH DELICATE TOUCHING AND CLASSICAL COLOR,
TO ADD VALUE FOR YOUR JEWELRY.

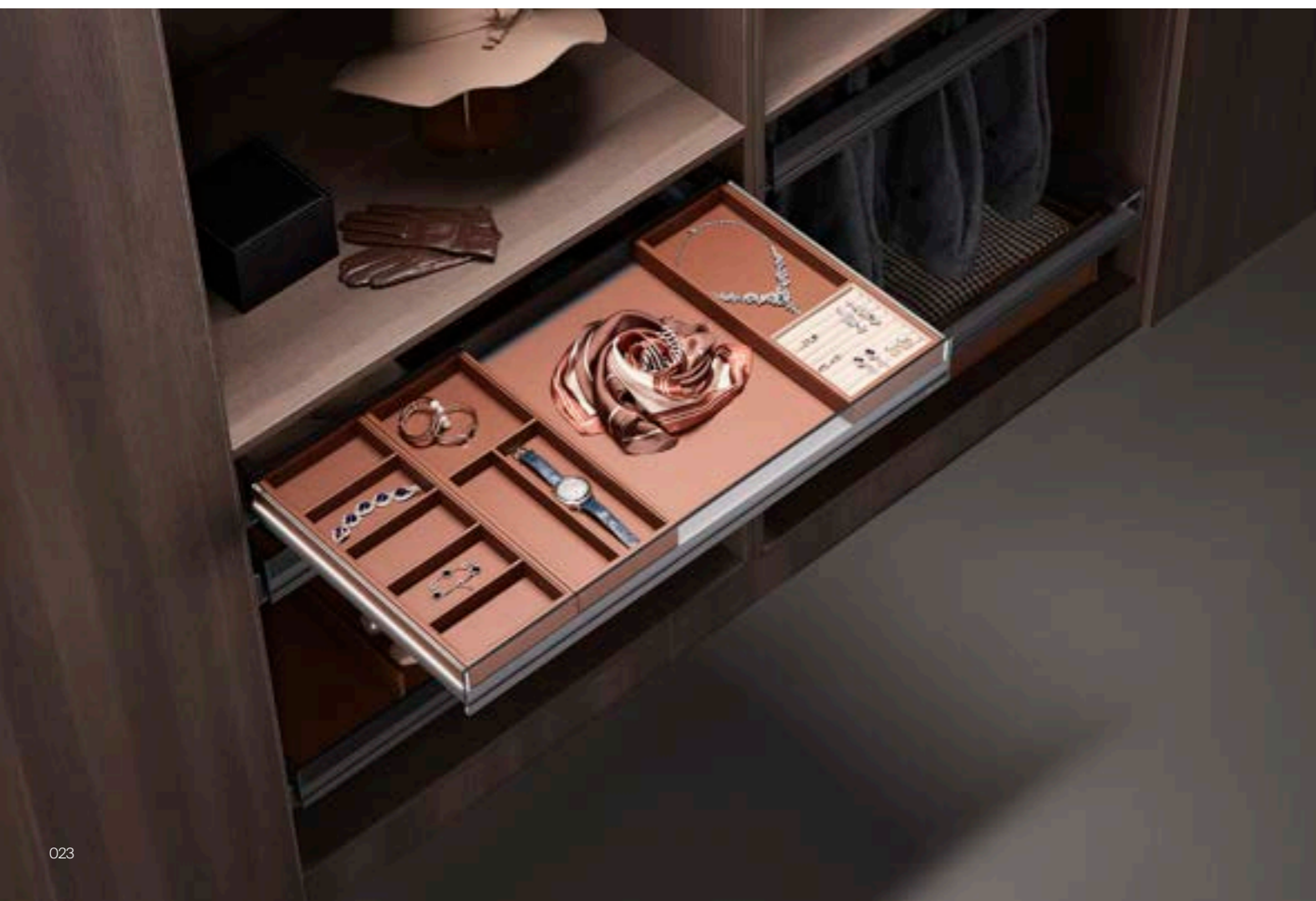



VENKA /
Leather multifunctional storage box

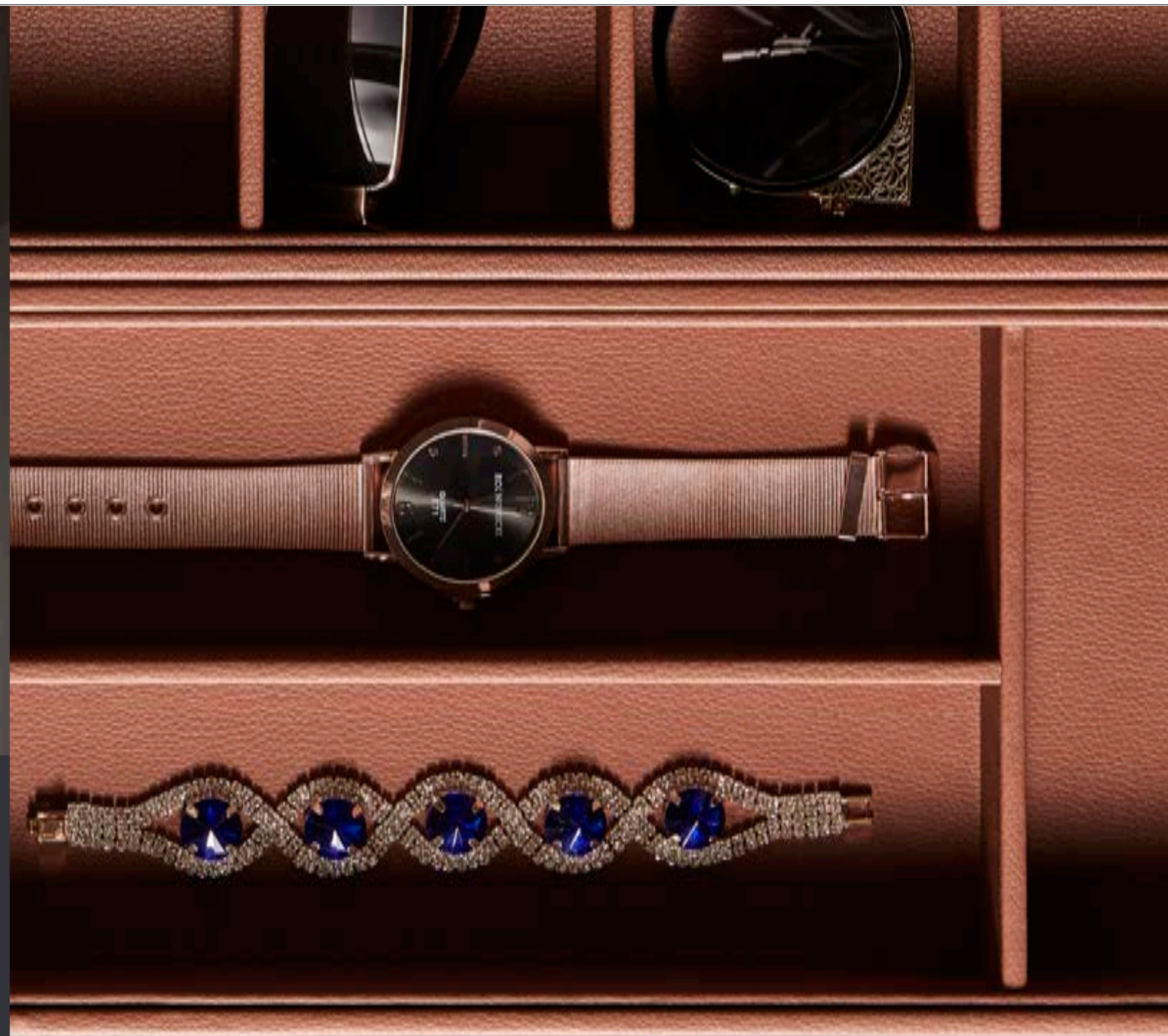



VENKA integrates materials and technology to create an elegant life for you.



VENKA /
Leather flat storage box



VENKA /
Glass flat storage box

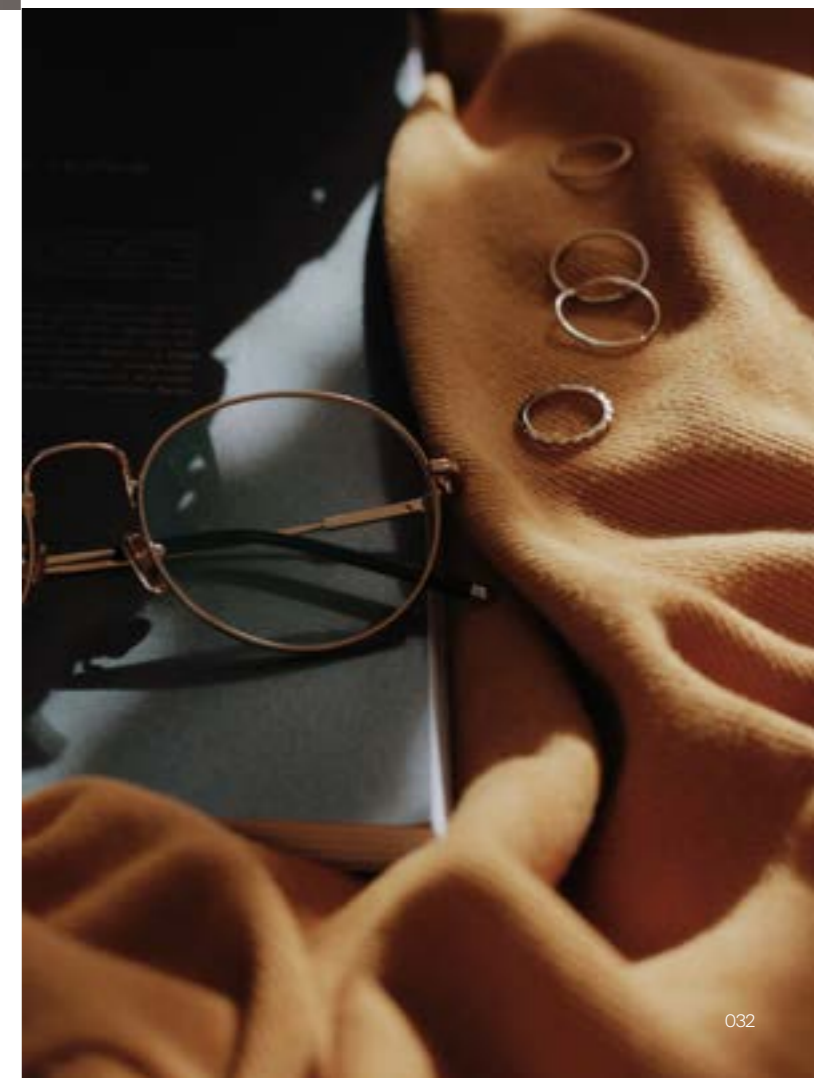

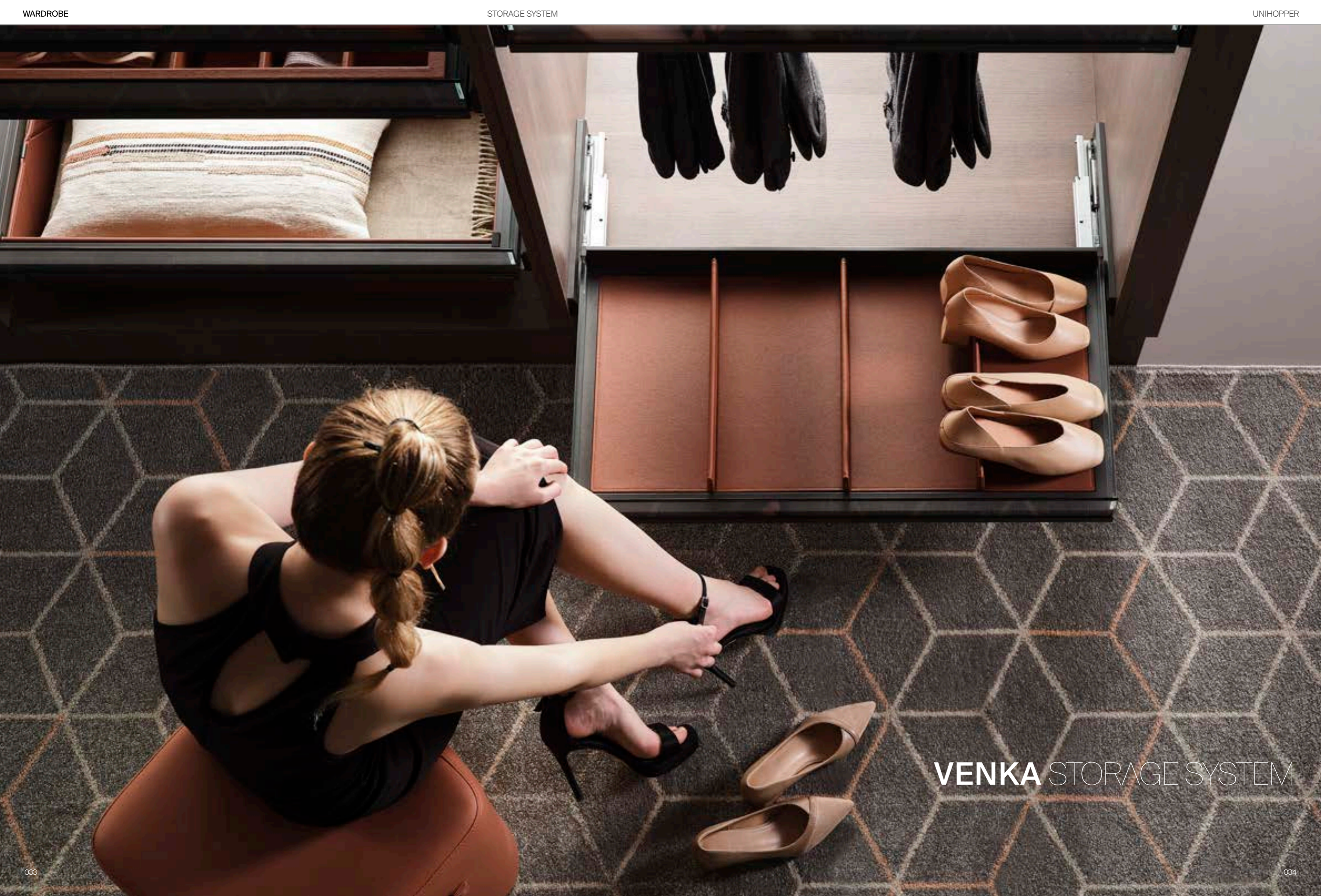

VENKA STORAGE SYSTEM

VENKA /
Leather shoes rack



THE THOUGHTFUL FUNCTION AND UNIQUE DESIGN, BRINGS YOU A BRAND NEW LIFE.





WELL-ORGANIZED WARDROBE STORAGE DESIGN
LET YOU ENJOY YOUR ORDERLY LIFE.

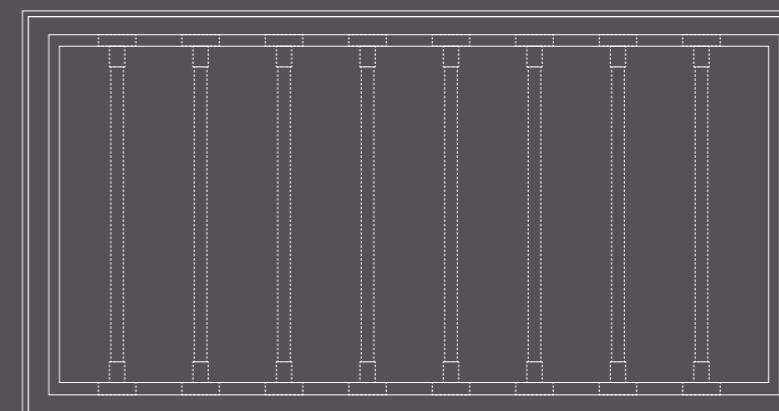

ANTI-SLIP AND ADJUSTABLE DESIGNED
TROUSERS BAR CREATES CONVENIENCE
FOR EVERYDAY.

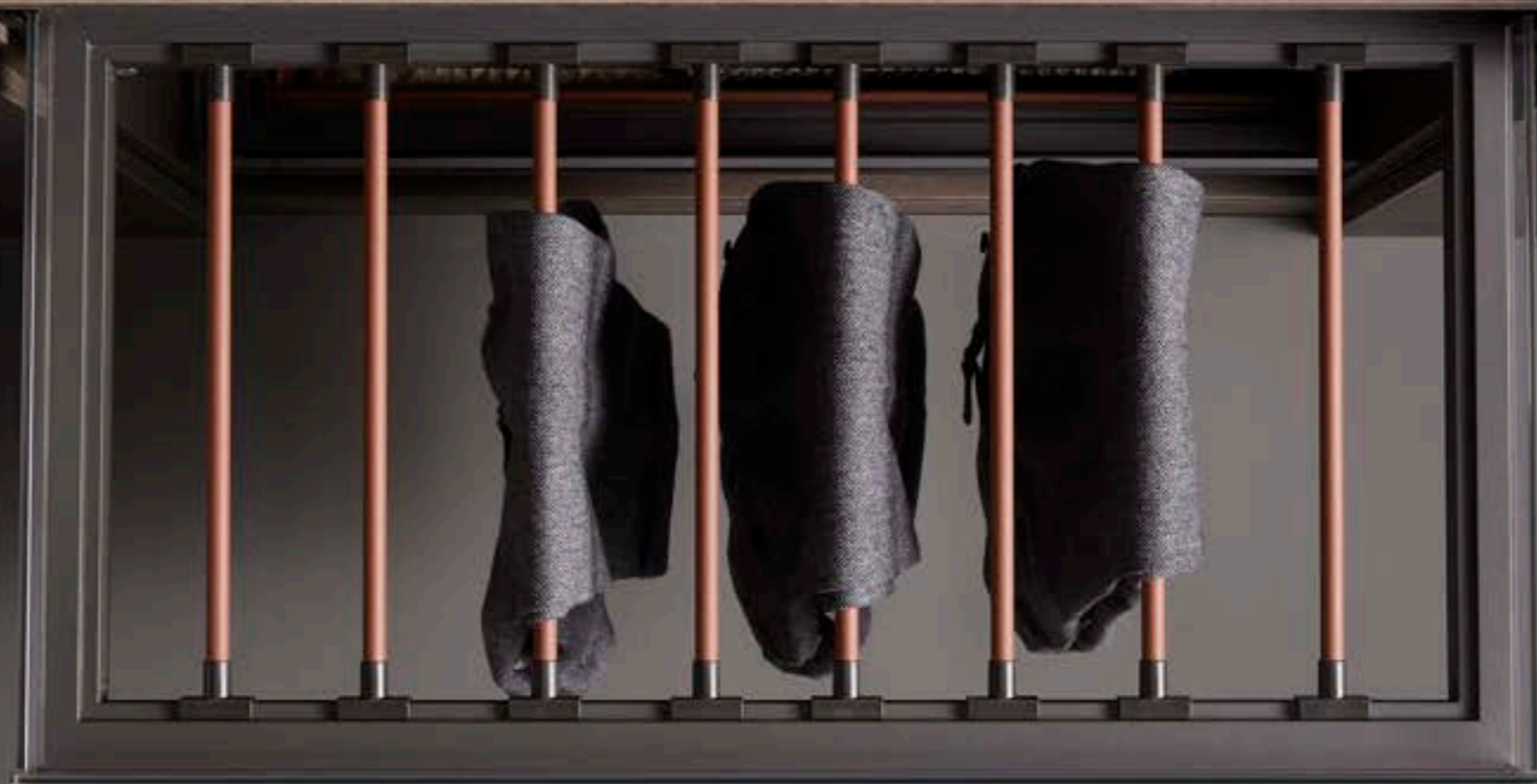

VENKA /
Leather trousers rack



LEATHER BAG FOR CLOTH--BEING ORDERLY, BEING ELEGANT.

VENKA /
Leather storage bag



THE LEATHER STORAGE BOX KEEPS YOUR UNDERWEAR A PERFECT STORAGE.

VENKA /
Leather underwear storage box





→ FEATURES

- A blending between LED luminous glass and leather conveys luxurious charm and elegant classics, bringing a warm and comfortable sensory enjoyment to people
- Quick assembly, linkage two way slow motion slide +high strength aluminum alloy general frame +LED luminous glass drawer side, combining with multifunctional storage boxes
- Color: Texture mocca (TCA)
- LED temperature 4000K



VENKA LEATHER MULTIFUNCTIONAL STORAGE BOX

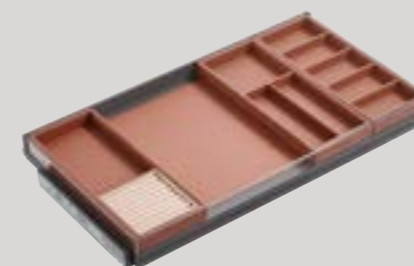

MODEL	CABINET W (mm)	WIDTH x DEPTH x HEIGHT (mm) With slides
WS4158S.060.TCA	600	564x457x81
WS4158S.080.TCA	800	764x457x81
WS4158S.090.TCA	900	864x457x81

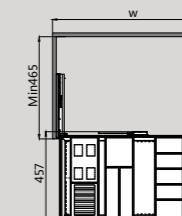

VENKA LEATHER MULTIFUNCTIONAL STORAGE BOX-GLASS BOTTOM PANEL

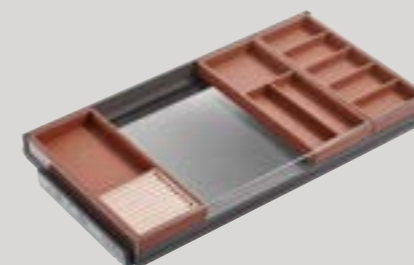

MODEL	CABINET W (mm)	WIDTH x DEPTH x HEIGHT (mm) With slides
WS4158S.060G.TCA	600	564x457x81
WS4158S.080G.TCA	800	764x457x81
WS4158S.090G.TCA	900	864x457x81

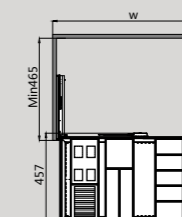

VENKA LEATHER FLAT STORAGE BOX

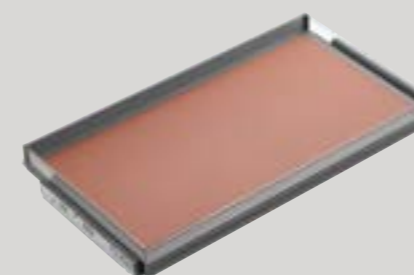

MODEL	CABINET W (mm)	WIDTH x DEPTH x HEIGHT (mm) With slides
WS4159S.060.TCA	600	564x457x81
WS4159S.080.TCA	800	764x457x81
WS4159S.090.TCA	900	864x457x81

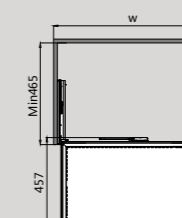



VENKA GLASS FLAT STORAGE BOX



MODEL	CABINET W (mm)	WIDTH x DEPTH x HEIGHT (mm) With slides
WS4159S.060G.TCA	600	564x457x81
WS4159S.080G.TCA	800	764x457x81
WS4159S.090G.TCA	900	864x457x81

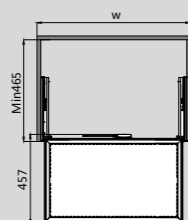

VENKA LEATHER STORAGE BAG

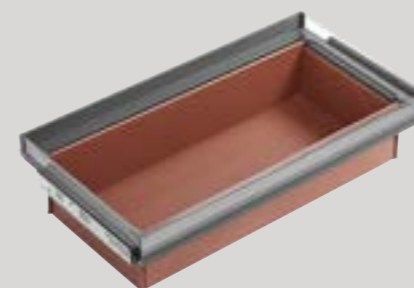

MODEL	CABINET W (mm)	WIDTH x DEPTH x HEIGHT (mm) With slides
WS4162S.060.TCA	600	564x457x212
WS4162S.080.TCA	800	764x457x212
WS4162S.090.TCA	900	864x457x212

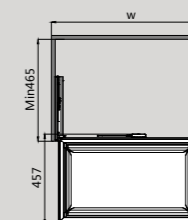

VENKA LEATHER SHOES RACK

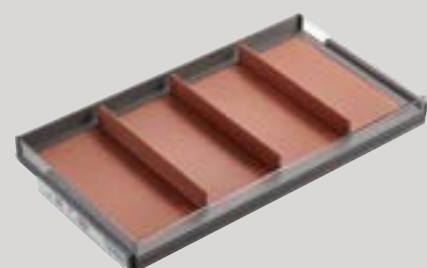

MODEL	CABINET W (mm)	WIDTH x DEPTH x HEIGHT (mm) With slides
WS4160S.060.TCA	600	564x457x86
WS4160S.080.TCA	800	764x457x86
WS4160S.090.TCA	900	864x457x86

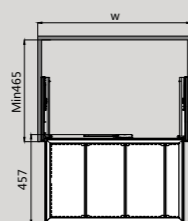

VENKA LEATHER UNDERWEARE STORAGE BOX



MODEL	CABINET W (mm)	WIDTH x DEPTH x HEIGHT (mm) With slides
WS4166S.060.TCA	600	564x457x121
WS4166S.080.TCA	800	764x457x121
WS4166S.090.TCA	900	864x457x121

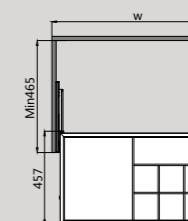

VENKA LEATHER TROUSERS RACK

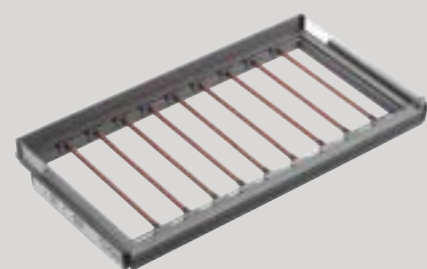

MODEL	CABINET W (mm)	WIDTH x DEPTH x HEIGHT (mm) With slides
WS4161S.060.TCA	600	564x457x81
WS4161S.080.TCA	800	764x457x81
WS4161S.090.TCA	900	864x457x81

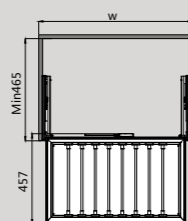



COKA STORAGE SYSTEM









SOFT AND DELICATE VELVET TO EMBELLISH THE JEWELRY BOX, CONVEY THE PROPER WAY FOR YOUR VALUABLES.



LIFE HAS A THOUSAND
KINDS OF ATTITUDE.





COKA /
Multifunctional storage box



Coka helps your stuff to be in orderly and better storage. The minimalism design expresses another outstanding life style.

COKA

COKA /
Metal storage box





COKA /
Shoes rack

COKA /
Multifunctional shoes rack







THE PERFECT COMBINATION OF ELEGANT AND PRAGMATISM,
IS THE WAY OF LIFE WE LOOK FORWARD TO.

COKA /
Storage wire basket





COKA /
Trousers rack



The beauty of orderliness.



“It feels like a luxury touch”, the elegant design is not restricted by any times and tide, but makes your wardrobe full of charming.

COKA /
Multifunctional storage box

DESIGN FOR STORAGE WITH SMOOTHLY WRAPPING VELVET, TO CARE FOR YOUR
INTIMATE CLOTHING AND YOUR HOME LIFE.





→ FEATURES

- Bringing conformable experience with simple design, Less is more, using less stuff to convey bigger zone of imagination.
- Quick assembly, two way slow motion slide +high strength aluminum alloy general frame, combining with multifunctional storage boxes adjustable -4~+30mm
- Color: Mink (MK)



COKA MULTIFUNCTIONAL STORAGE BOX



MODEL	CABINET W (mm)	WIDTH x DEPTH x HEIGHT (mm) With slides
WS4153S.060.MK	600	564x443x51
WS4153S.080.MK	800	764x443x51
WS4153S.090.MK	900	864x443x51

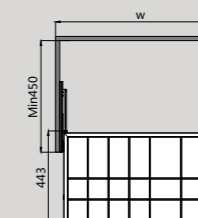

COKA METAL STORAGE BOX



MODEL	CABINET W (mm)	WIDTH x DEPTH x HEIGHT (mm) With slides
WS4154S.060.MK	600	564x443x51
WS4154S.080.MK	800	764x443x51
WS4154S.090.MK	900	864x443x51

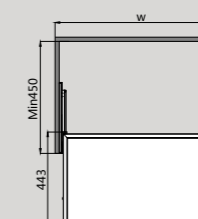

COKA SHOES RACK



MODEL	CABINET W (mm)	WIDTH x DEPTH x HEIGHT (mm) With slides
WS4155S.060.MK	600	564x443x51
WS4155S.080.MK	800	764x443x51
WS4155S.090.MK	900	864x443x51

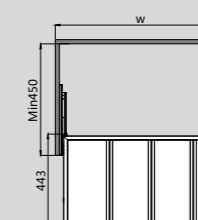



COKA STORAGE WIRE BASKET

MODEL	CABINET W (mm)	WIDTH x DEPTH x HEIGHT (mm) With slides
WS4170S.060.MK	600	564x443x186
WS4170S.080.MK	800	764x443x186
WS4170S.090.MK	900	864x443x186

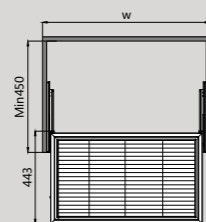

COKA MULTIFUNCTIONAL STORAGE BOX

MODEL	CABINET W (mm)	WIDTH x DEPTH x HEIGHT (mm) With slides
WS4167S.060.MK	600	564x443x122
WS4167S.080.MK	800	764x443x122
WS4167S.090.MK	900	864x443x122

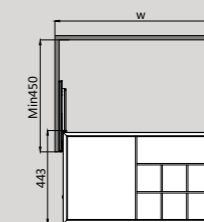

COKA TROUSERS RACK

MODEL	CABINET W (mm)	WIDTH x DEPTH x HEIGHT (mm) With slides
WS4157S.060.MK	600	564x443x51
WS4157S.080.MK	800	764x443x51
WS4157S.090.MK	900	864x443x51

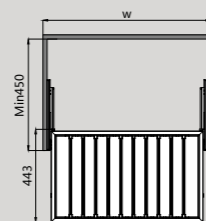

COKA MULTIFUNCTIONAL SHOES RACK

MODEL	CABINET W (mm)	WIDTH x DEPTH x HEIGHT (mm) With slides
WS4168S.060.MK	600	564x443x141
WS4168S.080.MK	800	764x443x141
WS4168S.090.MK	900	864x443x141

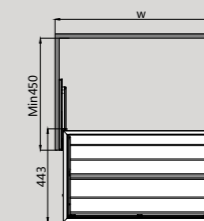



GLASS NAKA STORAGE SYSTEM



NOBILITY IS NOT MATERIAL LUXURY, BUT A REFINED ATTITUDE TO LIFE.

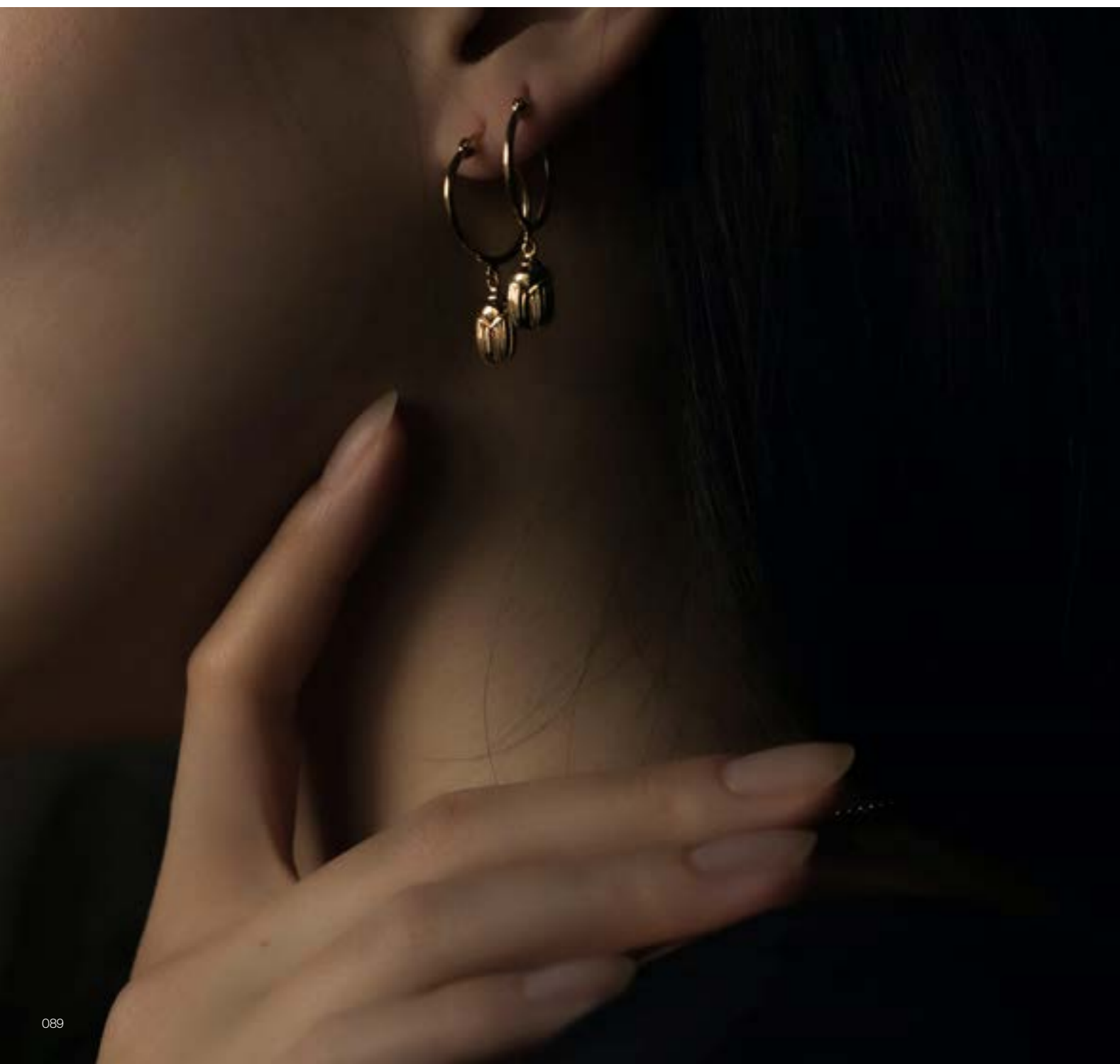

GLASS NAKA COMBINES ELEGANCE WITH PRAGMATISM TO MEET ALL EXPECTATIONS OF QUALITY LIFE AND IS THE WAY WE HAVE LONG LOOKED FORWARD TO IT.

GLASS NAKA STORAGE SYSTEM



GLASS NAKA /
Multifunctional storage box



EXTRAORDINARY VISUAL ENJOYMENT WITH
FUNCTIONAL AND STYLISH DESIGN, TO
STORE THE JEWELRY PERFECTLY.



MULTI-FUNCTIONAL AND CABINET-STYLED DESIGN IS UTILITY TO MAKE GOOD USE OF THE WARDROBE SPACE.



GLASS NAKA /
Pvc rattan storage basket

GLASS NAKA /
Board type storage box



GLASS NAKA /
Simple style trousers rack



THE TROUSERS RACK WITH ANTI-SLIP
DESIGN, KEEP THE PANTS ORDERLY AND
MAKE IT EASY FOR TAKING.



GLASS NAKA /
Board type shoes rack





→ FEATURES

- Two-way soft closing, soft closing distance 53mm adjustable max +20mm
- High-strength aluminium frame+glass panel, combining with multifunctional storage boxes
- Color: Mocca (MCA)

GLASS NAKA BOARD TYPE STORAGE BOX



MODEL	CABINET W (mm)	WIDTH x DEPTH x HEIGHT (mm) With slides
WS4142S.060G.MCA	600	564~584x443x140
WS4142S.080G.MCA	800	764~784x443x140
WS4142S.090G.MCA	900	864~884x443x140

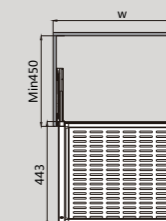

GLASS NAKA MULTIFUNCTIONAL STORAGE BOX



MODEL	CABINET W (mm)	WIDTH x DEPTH x HEIGHT (mm) With slides
WS4140S.060G.MCA	600	564~584x443x78
WS4140S.080G.MCA	800	764~784x443x78
WS4140S.090G.MCA	900	864~884x443x78

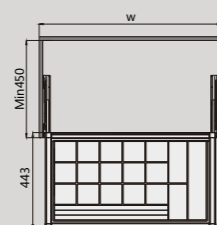

GLASS NAKA SIMPLE STYLE TROUSERS RACK



MODEL	CABINET W (mm)	WIDTH x DEPTH x HEIGHT (mm) With slides
WS4143S.060G.MCA	600	564~584x443x63
WS4143S.080G.MCA	800	764~784x443x63
WS4143S.090G.MCA	900	864~884x443x63

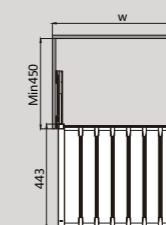

GLASS NAKA PVC RATTAN STORAGE BASKET

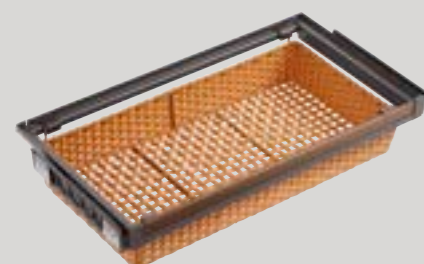

MODEL	CABINET W (mm)	WIDTH x DEPTH x HEIGHT (mm) With slides
WS4141S.060G.MCA	600	564~584x443x151
WS4141S.080G.MCA	800	764~784x443x151
WS4141S.090G.MCA	900	864~884x443x151

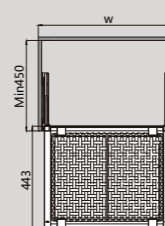

GLASS NAKA BOARD TYPE SHOES RACK



MODEL	CABINET W (mm)	WIDTH x DEPTH x HEIGHT (mm) With slides
WS4144S.060G.MCA	600	564~584x443x204
WS4144S.080G.MCA	800	764~784x443x204
WS4144S.090G.MCA	900	864~884x443x204

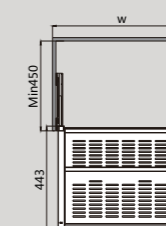

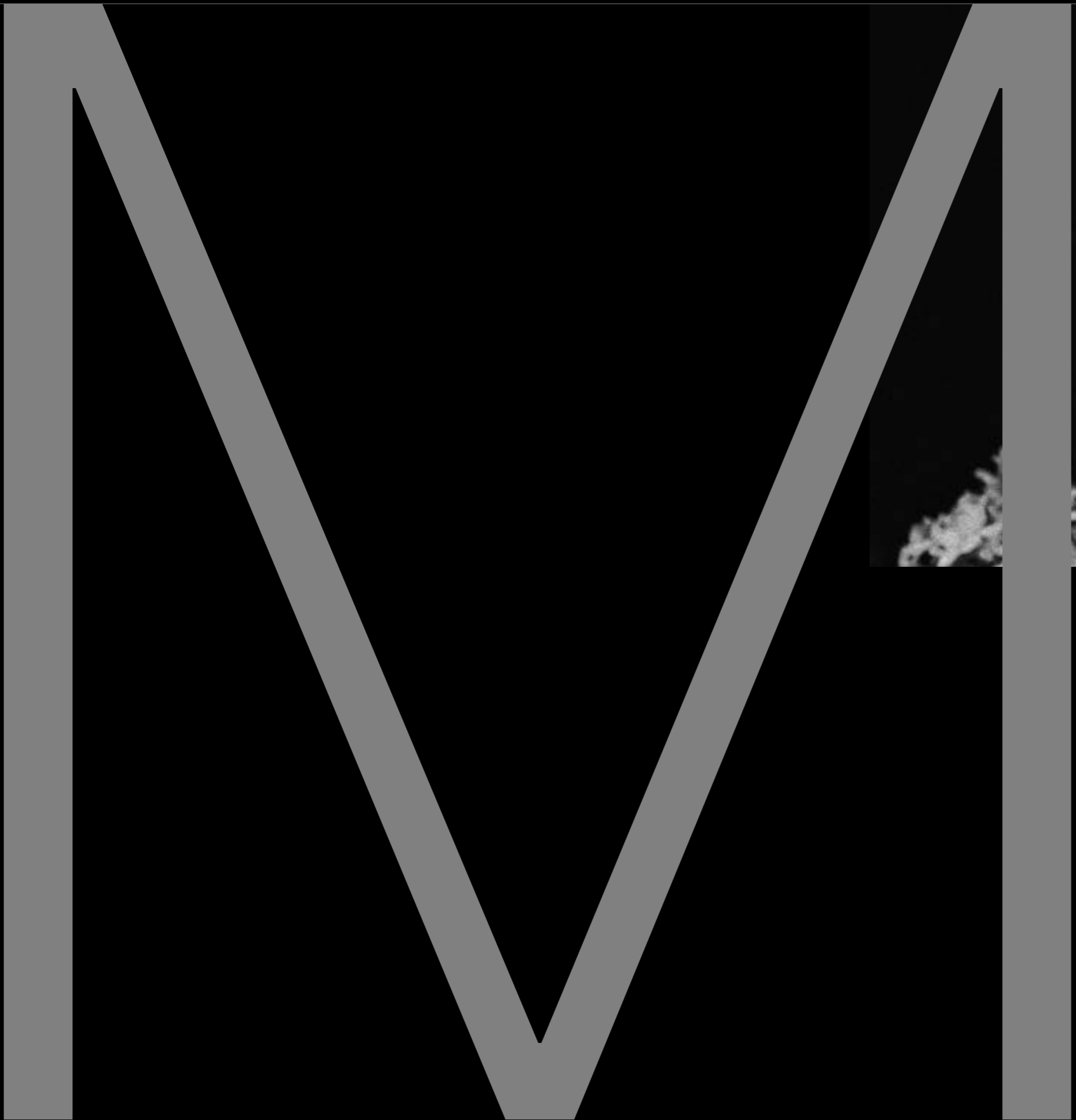

MOKA STORAGE SYSTEM





Wardrobe style reflects the pursuit of life.

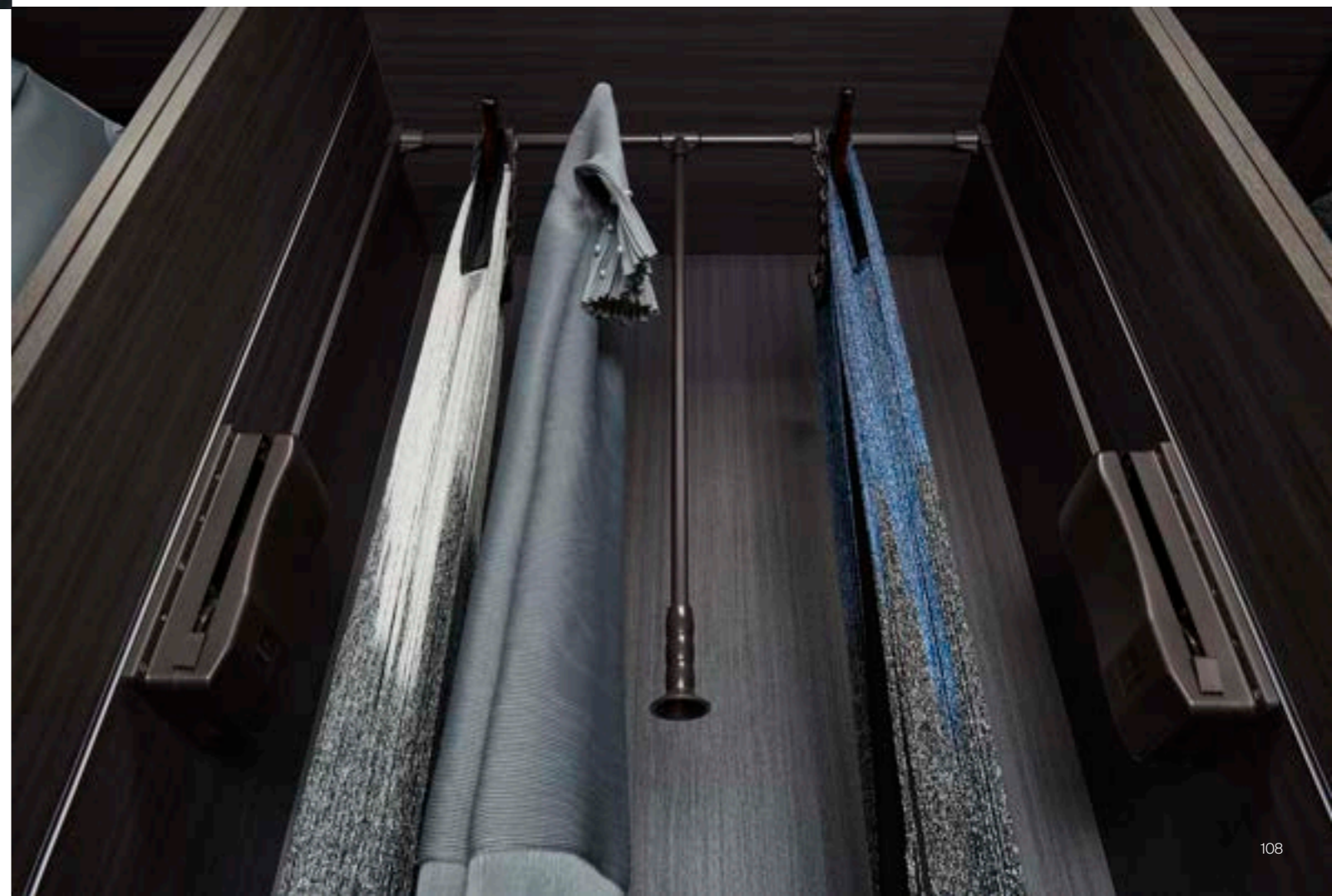

An encounter in modernity and art,
better enjoy the sense of elegance and
temperament.

Premium texture with elegance.



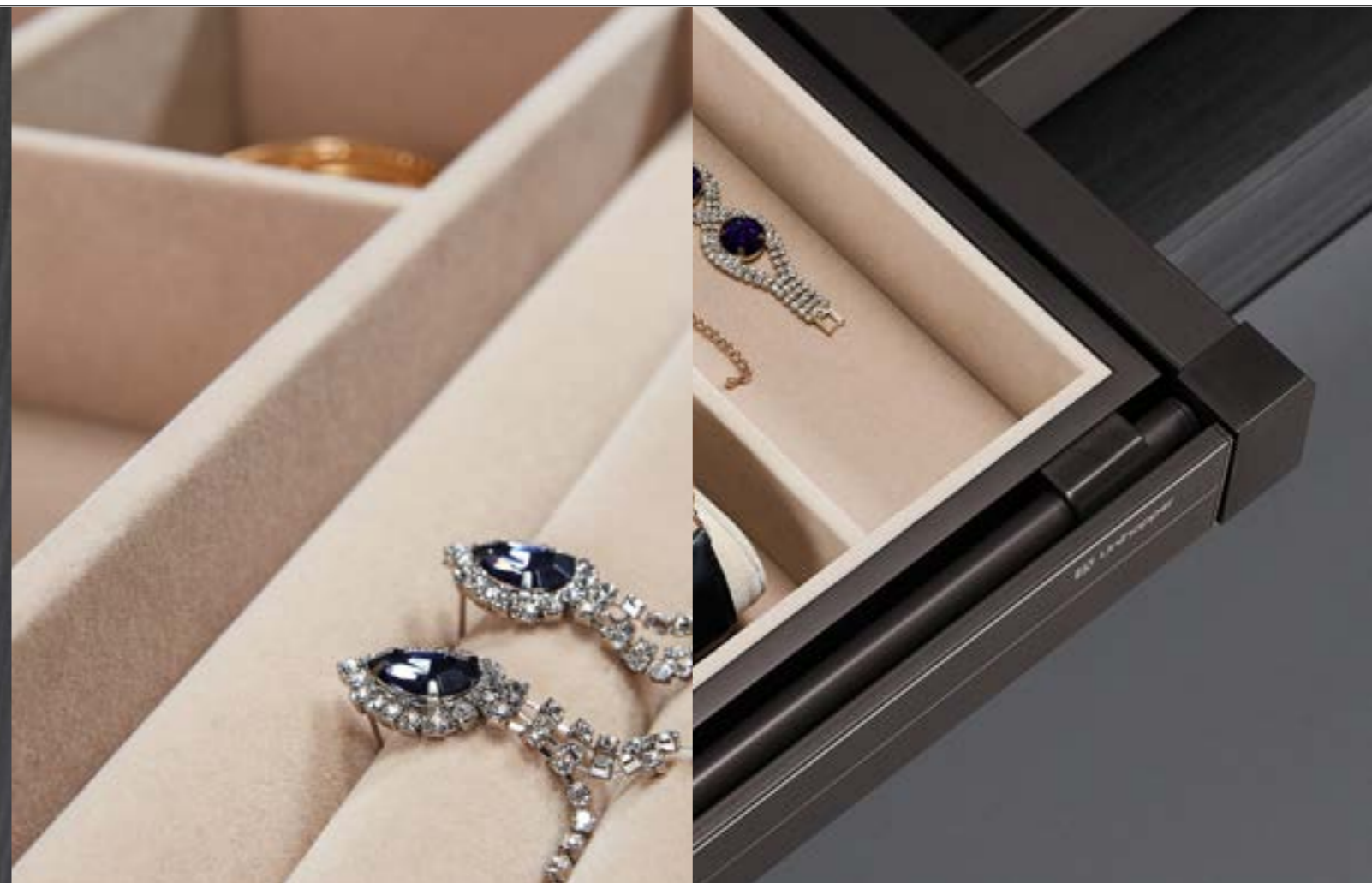

MOKA /
Multifunctional storage box

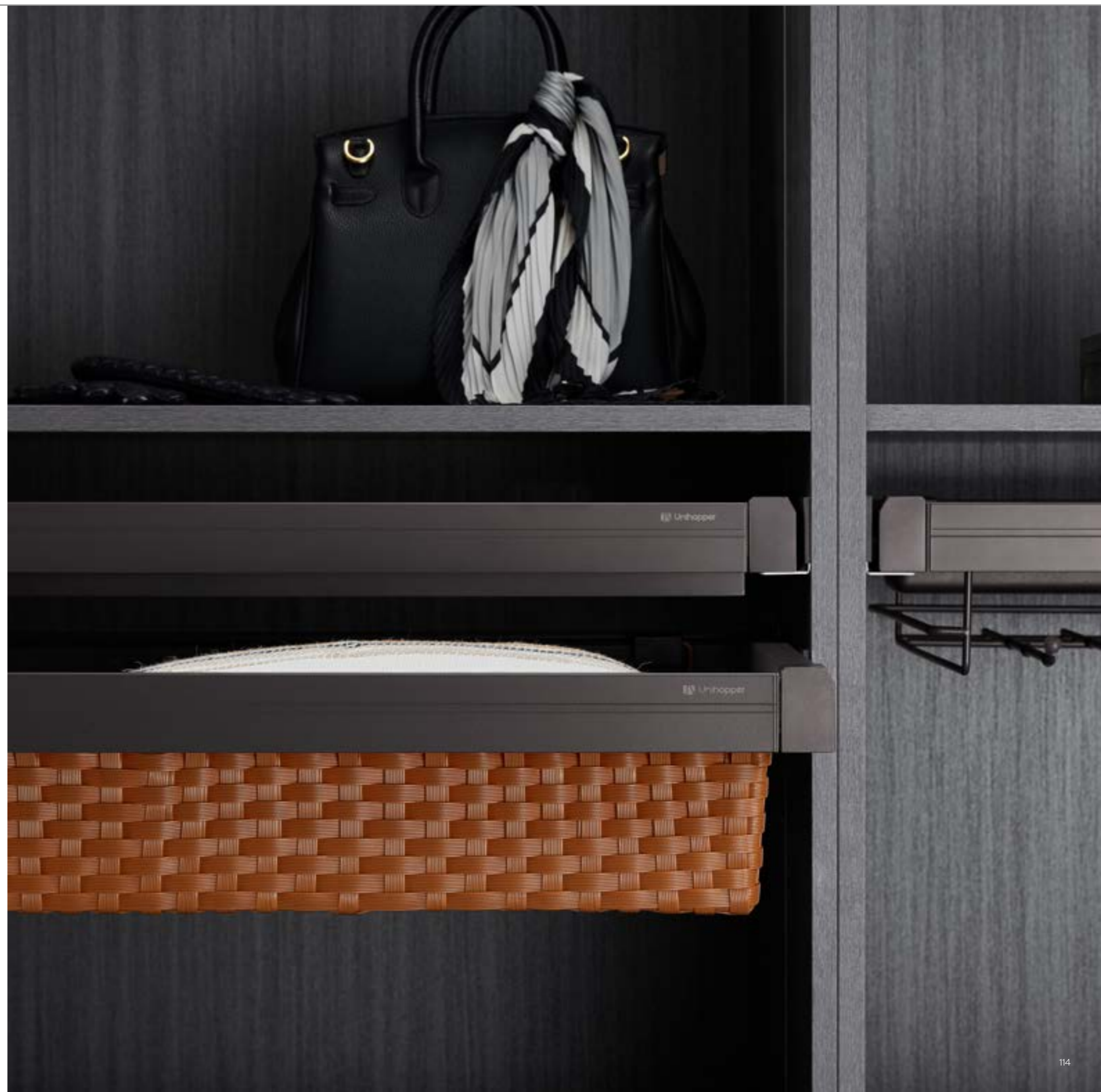

MOKA /
Pvc rattan storage basket



THE RATTAN DESIGN FOR STORAGE WITH THE STYLE FOR MINIMALIST- SIMPLE BUT LUXURY.



MOKA /
Flat and shallow board type
storage basket



MOKA /
Metal wire storage basket





MOKA /
Simple trousers rack



MOKA /
Board type shoes rack



MOKA /
Board type shoes rack



MOKA /
Glasses drawer



THE GLASS INBUILT WITH THE VISUAL TRANSLUCENCY, TO PRESENT THE LAYERING OF STORAGE, TO TRANSLATE THE ESSENCE OF LIFE.



MOKA /
Side mounted 4 layers
shoes rack

MOKA /
Side mounted 4 layers
storage rack



MOKA /
VICTORA

NEW



INNOVATIVE DESIGN OF LIFTING—TO PASS ON THE
CONSIDERATION AND CONVENIENCE!

Reach to the height





MOKA /
Soft closing wardrobe lift

SOFT CLOSING LIFTING, TO REACH OF THE HEIGHT, TO CREATE TASTEFUL LIFE!



MOKA CLOTHES HANGER OFFERING THE BEST WARDROBE EXPERIENCE FOR YOU! TOP-MOUNTED DESIGN FOR QUICK ASSEMBLE, ORDERLY STORAGE FOR QUALITY LIFE.

MOKA /
Ballet



MOKA /
Clothes hanger



MOKA /
Clothes hanger





MOKA /
Clothes hanger

THE MOKA CLOTHES HANGER PERFECTLY MATCHES FOR THE WARDROBE STORAGE, ORDERLY AND STYLISH.



MOKA /
Clothes hanger

LIFE AS A MIRROR! BEING AN ELEGANT LADY, THE MOKA SOFT CLOSING ROTATED MIRROR OFFERING THE BEST REFERENCE.

MOKA /
Soft closing rotated mirror



MOKA /
Soft closing rotated mirror

MOKA /
Pt rotating mirror





SPACE-SAVING AND PRACTICAL DESIGN TO ACHIEVE THE FUNCTIONS OF SOFT CLOSING AND EASY FOR TAKING!

MOKA /
Soft closing top mounting
clothes hanger

MOKA /
Soft closing side mounted
tie rack



Waltz perfectly solves the full use of corner space, 360 degree rotating brings you good experience for collection and dressing up.

WARDROBE IN DANCING

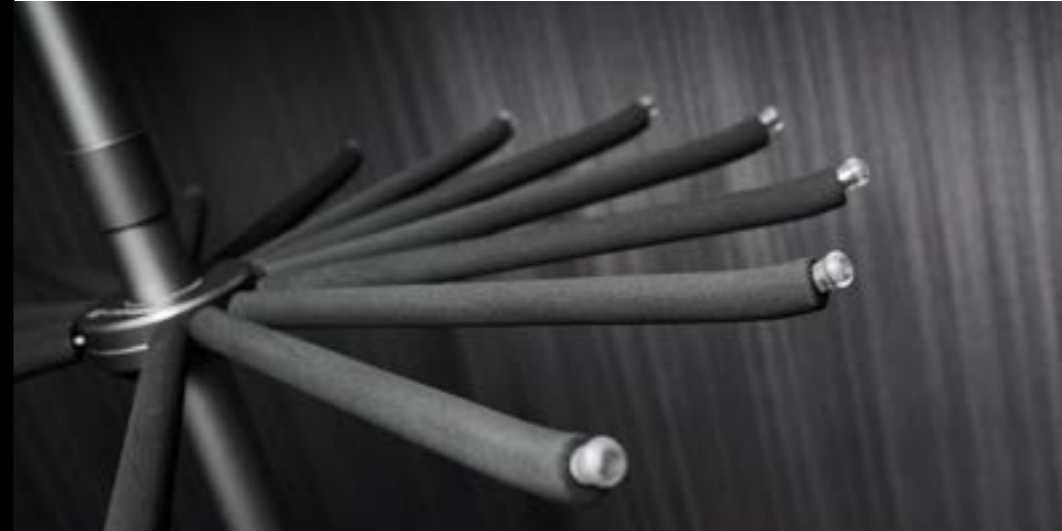



MOKA /
3 layers of rotating basket

WITH MINIMALIST AND PRACTICAL DESIGN,
IT PROVIDES A VARIETY OF SPACE WITH
MULTIFUNCTIONAL STORAGE, REALIZING THE
FREEDOM FROM STATIC TO DYNAMIC.



HIGH END MOCCA FINISHING RELEASES HIGH QUALITY FEELING, 360 DEGREE ROTATING DESIGN HELPS YOU PICK OUT AND COLLECT SHOES EASILY.





MOKA /
360 degree rotating shoe rack



LOCKBOX WITH THE DOUBLE-SAFETY DESIGN OF PASSWORD AND FINGERPRINTING, INCREASING THE INTELLIGENT SECURITY FOR THE CHERISHED STUFFS.



MOKA /
Lockbox

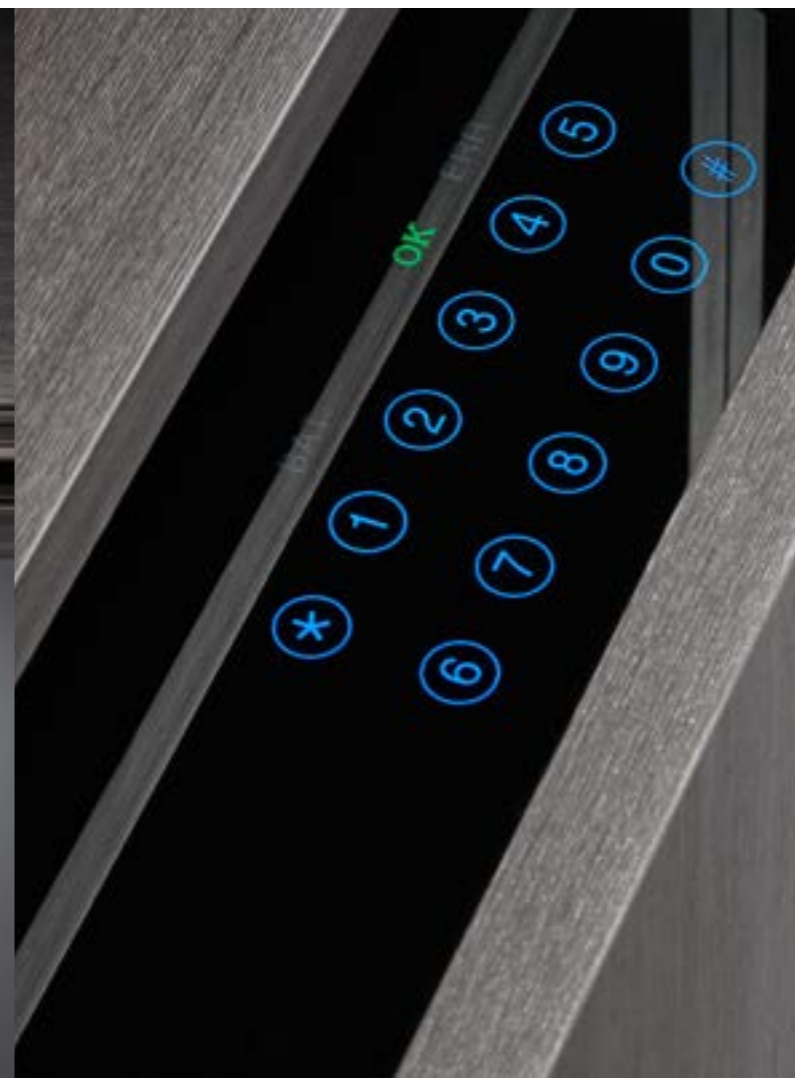
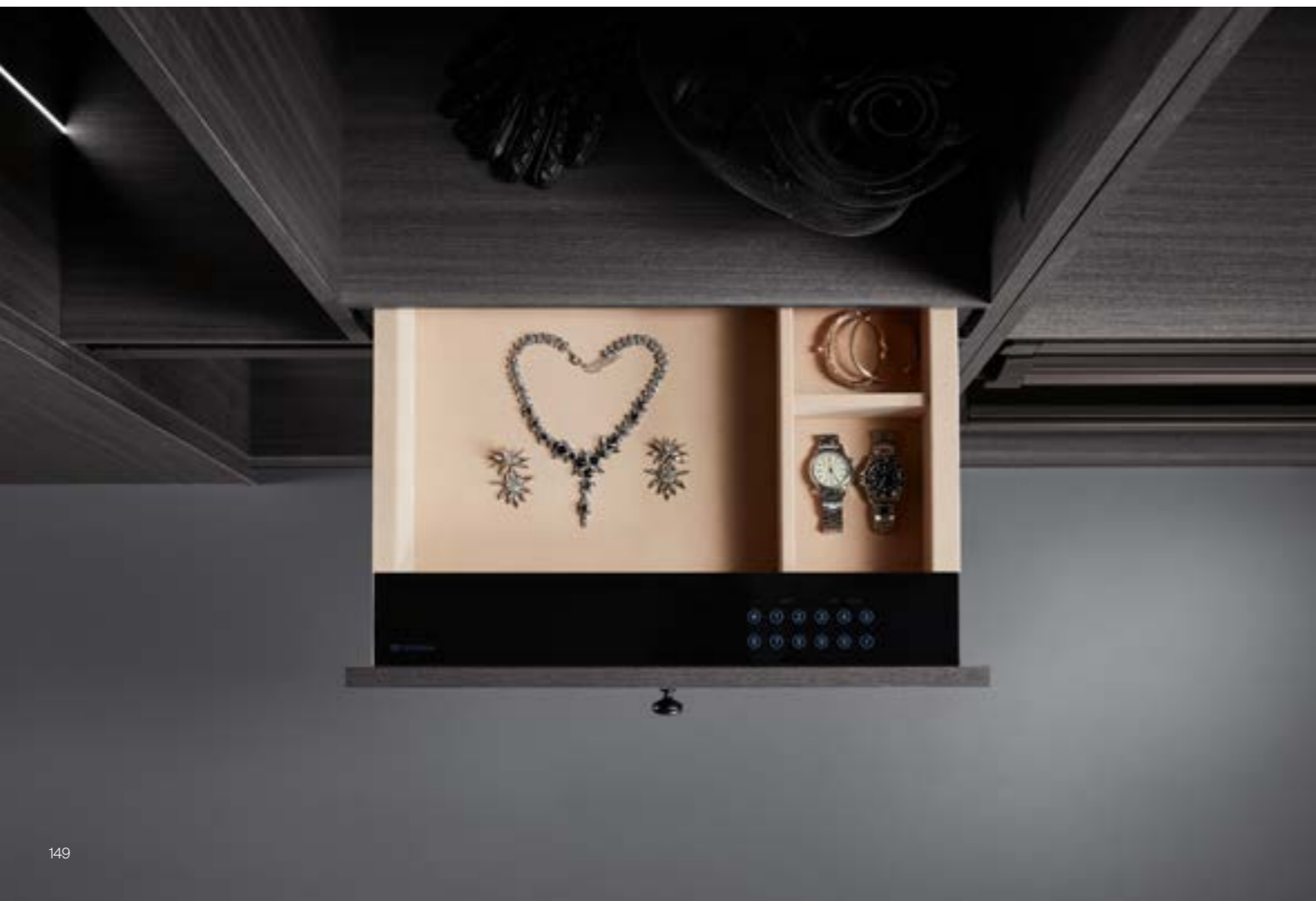



→ FEATURES

- Two-way soft closing, soft closing distance 53mm, adjustable max +46mm
- High-strength aluminium frame, combining with multifunctional storage boxes
- Color: Mocca (MCA)/White (WT)



MULTIFUNCTIONAL STORAGE BOX

MODEL	CABINET W (mm)	WIDTH x DEPTH x HEIGHT (mm) With slides
WS4117S.060.(^)	600	564~610x443x78
WS4117S.080.(^)	800	764~810x443x78
WS4117S.090.(^)	900	864~910x443x78

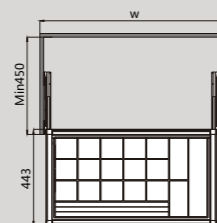

PVC RATTAN STORAGE BASKET

MODEL	CABINET W (mm)	WIDTH x DEPTH x HEIGHT (mm) With slides
WS4119S.060.(^)	600	564~610x443x170
WS4119S.080.(^)	800	764~810x443x170
WS4119S.090.(^)	900	864~910x443x170

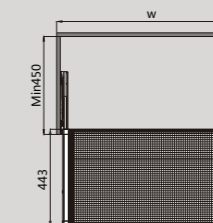
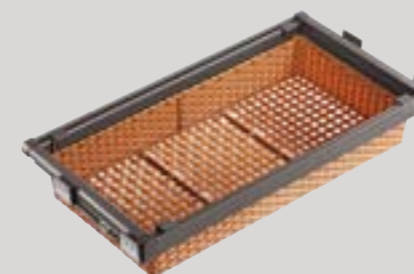

FLAT AND SHALLOW BOARD TYPE STORAGE BASKET

MODEL	CABINET W (mm)	WIDTH x DEPTH x HEIGHT (mm) With slides
WS4120S.060A.(^)	600	564~610x443x90
WS4120S.060B.(^)	600	564~610x443x135
WS4120S.080A.(^)	800	764~810x443x90
WS4120S.080B.(^)	800	764~810x443x135
WS4120S.090A.(^)	900	864~910x443x90
WS4120S.090B.(^)	900	864~910x443x135

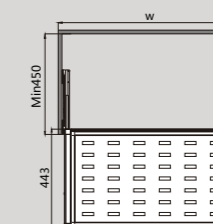

METAL WIRE STORAGE BASKET

MODEL	CABINET W (mm)	WIDTH x DEPTH x HEIGHT (mm) With slides
WS4121S.060A.(^)	600	564~610x443x130
WS4121S.060B.(^)	600	564~610x443x210
WS4121S.080A.(^)	800	764~810x443x130
WS4121S.080B.(^)	800	764~810x443x210
WS4121S.090A.(^)	900	864~910x443x130
WS4121S.090B.(^)	900	864~910x443x210

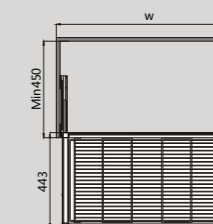
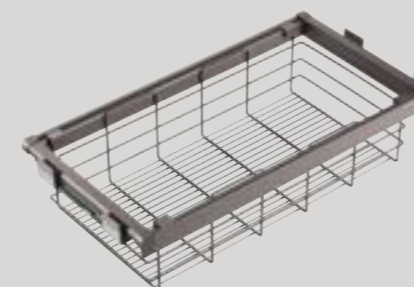

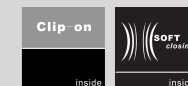

SIMPLE TROUSERS RACK

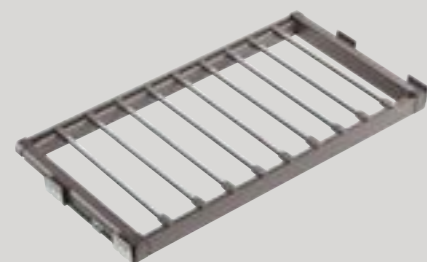

MODEL	CABINET W (mm)	WIDTH x DEPTH x HEIGHT (mm) With slides
WS4122S.060.(A)	600	564~610x443x60
WS4122S.080.(A)	800	764~810x443x60
WS4122S.090.(A)	900	864~910x443x60

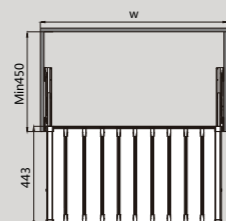

BOARD TYPE SHOES RACK

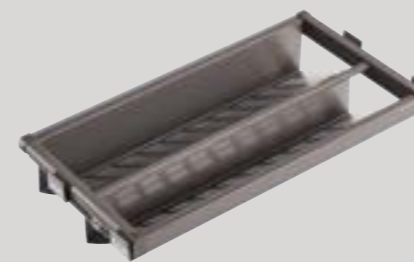

MODEL	CABINET W (mm)	WIDTH x DEPTH x HEIGHT (mm) With slides
WS4126S.060.(A)	600	564~610x443x210
WS4126S.080.(A)	800	764~810x443x210
WS4126S.090.(A)	900	864~910x443x210

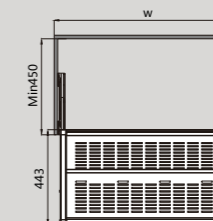

GLASSES DRAWER

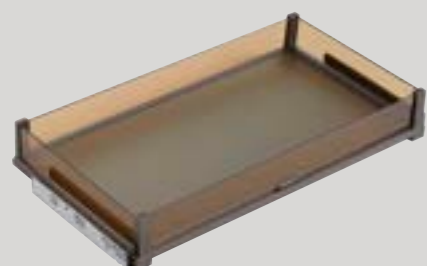

MODEL	CABINET W (mm)	WIDTH x DEPTH x HEIGHT (mm) With slides
WS4128S.045.(A)	450	414x448x130
WS4128S.050.(A)	500	464x448x130
WS4128S.060.(A)	600	564x448x130
WS4128S.070.(A)	700	664x448x130
WS4128S.080.(A)	800	764x448x130
WS4128S.090.(A)	900	864x448x130

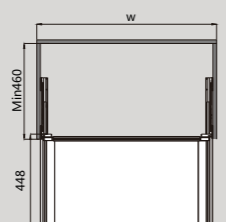

SIDE MOUNTED 4 LAYERS STORAGE RACK



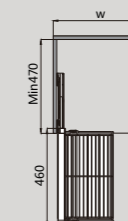

MODEL	CABINET W (mm)	WIDTH x DEPTH x HEIGHT (mm) With slides
WS4515RS.305.(A)	400	305x460x870
WS4515LS.305.(A)	400	305x460x870



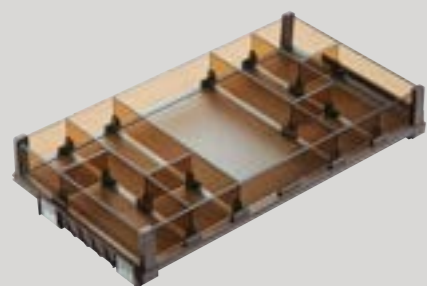

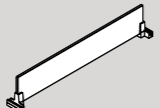
GLASS DIVIDER SYSTEM

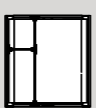

Horizontal divider 	Vertical divider 
MODEL:WS4128B1.412.(A)	MODEL:WS4128B1.120.(A)

Remarks:(A):Color: Ground glass(GD) / Transparent(TR)/ Brown(BR)

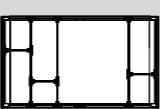
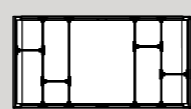
450mm Cabinet width 	600mm Cabinet width 
MODEL:WS4128E.045.(A)	MODEL:WS4128E.060.(A)
800mm Cabinet width 	900mm Cabinet width 
MODEL:WS4128E.080.(A)	MODEL:WS4128E.090.(A)

SIDE MOUNTED 4 LAYERS SHOES RACK



MODEL	CABINET W (mm)	WIDTH x DEPTH x HEIGHT (mm) With slides
WS4514RS.305.(A)	400	305x460x870
WS4514LS.305.(A)	400	305x460x870

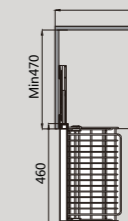



VICTORA

NEW



MODEL	CABINET W (mm)	MATERIAL
WS2105S.S.MCA	550-670	Aluminium
WS2105S.M.MCA	650-920	Aluminium
WS2105S.L.MCA	880-1270	Aluminium

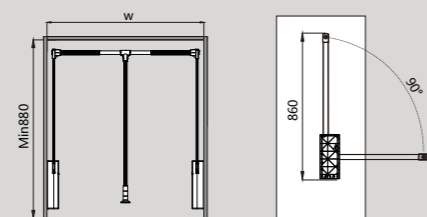

BALLET



MODEL	DESCRIBE	LENGTH (mm)
TS1409.014.MCA	Top/Side mounted hanger	
TS1410.014.MCA	Corner hanger	
AP2264.MCA	Wardrobe Tube	≤3000

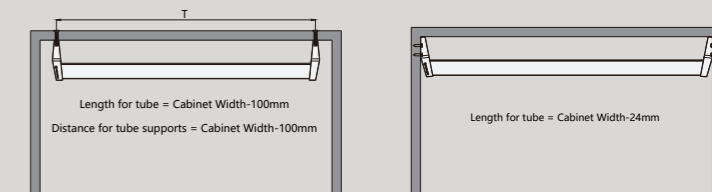

SOFT CLOSING WARDROBE LIFT



MODEL	CABINET W (mm)	MATERIAL
WS2101S.060.(^)	550-670	Aluminium
WS2101S.083.(^)	650-920	Aluminium
WS2101S.115.(^)	880-1270	Aluminium
WS2201S.060.(^)	550-670	Steel
WS2201S.083.(^)	650-920	Steel
WS2201S.115.(^)	880-1270	Steel

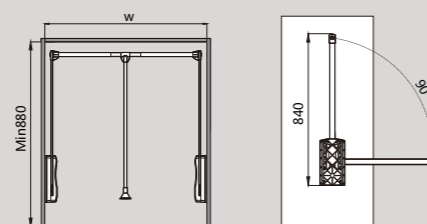

CLOTHES HANGER



MODEL	DESCRIBE	LENGTH (mm)
TS1403.012.(^)	Side mounted hanger	
AP2175.(^)	Wardrobe Tube	≤3000

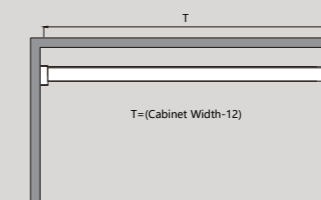

CLOTHES HANGER



MODEL	DESCRIBE	LENGTH (mm)
TS1401.012.(^)	Top amounted hanger	
TS1402.012.(^)	Middle top amounted hanger	
TS1404.012.(^)	Corner hanger	
AP2175.(^)	Wardrobe Tube	≤3000

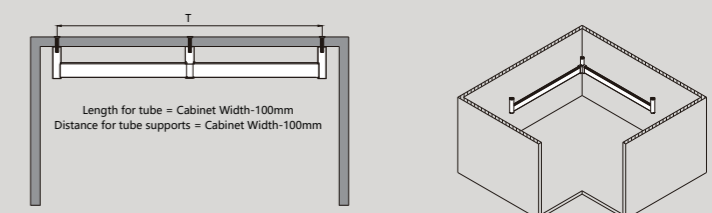

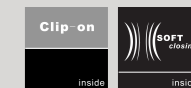

SOFT CLOSING ROTATED MIRROR



MODEL	CABINET W (mm)	WIDTH x DEPTH x HEIGHT (mm) With slides
-------	----------------	--

WS3103S.170.(*)	300	170x415x1130
-----------------	-----	--------------

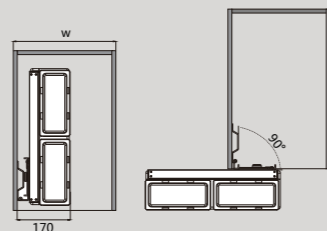

SOFT CLOSING TOP MOUNTING CLOTHES HANGER



MODEL	CABINET W (mm)	WIDTH x DEPTH x HEIGHT (mm) With slides
-------	----------------	--

WS4307S.(*)	250	85x445x160
-------------	-----	------------

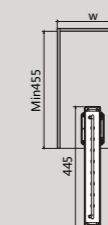

SOFT CLOSING ROTATED MIRROR



MODEL	CABINET W (mm)	WIDTH x DEPTH x HEIGHT (mm) With slides
-------	----------------	--

WS3104S1.020.(*)	300	52x423x1040
------------------	-----	-------------

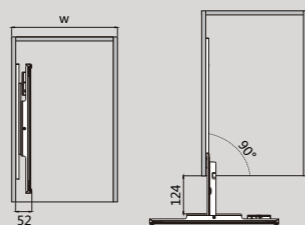

SOFT CLOSING SIDE MOUNTED TIE RACK



MODEL	CABINET W (mm)	WIDTH x DEPTH x HEIGHT (mm) With slides
-------	----------------	--

WS4310S.(*)	250	170x445x85
-------------	-----	------------

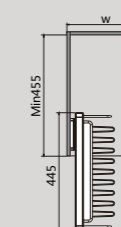

PT ROTATING MIRROR



MODEL	CABINET W (mm)	WIDTH x DEPTH x HEIGHT (mm) With slides
-------	----------------	--

WS3105.020.MCA	300	40x340x1000
----------------	-----	-------------

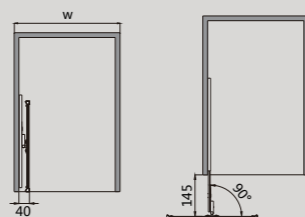

LOCKBOX



MODEL	CABINET W (mm)	WIDTH x DEPTH x HEIGHT (mm) With slides
-------	----------------	--

WS4138.(*)	600	564x400x150
------------	-----	-------------

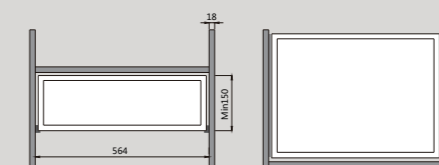

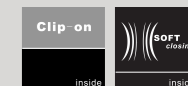

3 LAYERS OF ROTATING BASKET

MODEL	CABINET W (mm)	WIDTH x DEPTH x HEIGHT (mm) With slides	DESCRIBE
WS4152.MCA	800	700x700x1900-2100	Full set

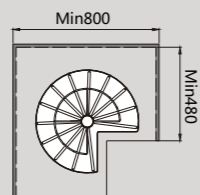
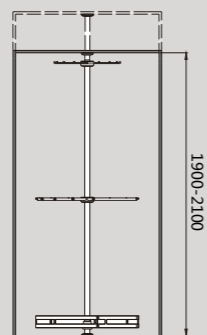
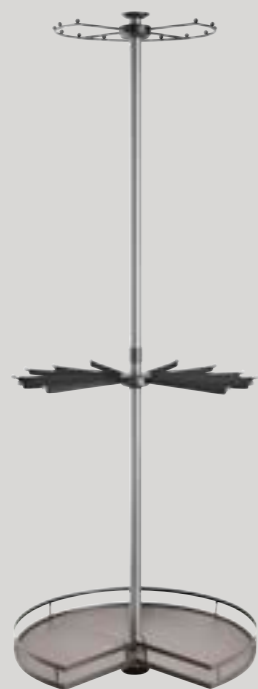

MODEL	CABINET W (mm)	WIDTH x DEPTH x HEIGHT (mm) With slides	DESCRIBE
WS4152.080L.MCA	800	700x700x1900-2100	Full set
WS4152.BYW		700x700	Leather sheets

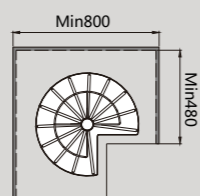
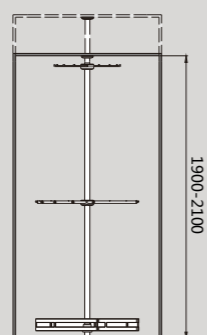
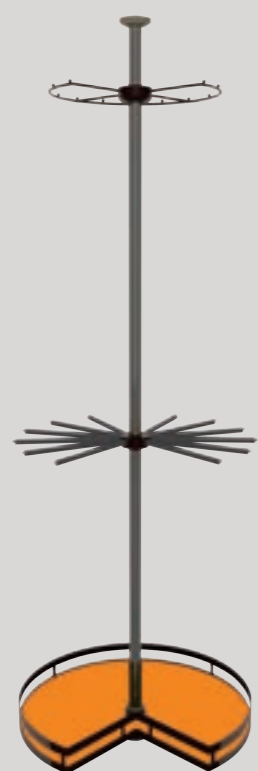

360 DEGREE ROTATING SHOE RACK

MODEL	CABINET W (mm)	WIDTH x DEPTH x HEIGHT (mm) With slides	DESCRIBE
WS4518S.080K.MCA	800	700x365x1920-2210	12 Layers
WS4518S.080G.MCA	800	700x365x1360-1650	8 Layers

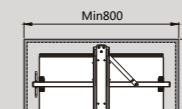
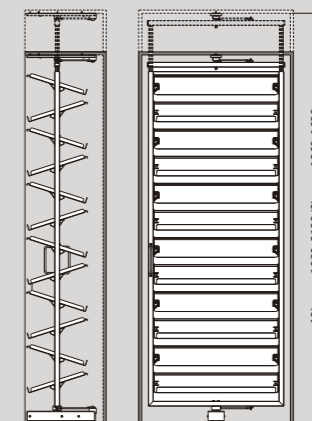

MODEL	CABINET W (mm)	WIDTH x DEPTH x HEIGHT (mm) With slides	DESCRIBE
WS4518S.080KL.MCA	800	700x365x1920-2210	12 Layers
WS4518S.080GL.MCA	800	700x365x1360-1650	8 Layers
WS4518.BYW		638x300	Leather sheets X1

